

# GENUINE MUD FLAP (FRONT)

## INSTALLATION AND USER'S INSTRUCTIONS

Thank you for purchasing a Genuine Mazda Accessory.





Before removal and installation, be sure to thoroughly read these instructions.

Please read the contents of this booklet to properly install and use the mud flap (front).

Your safety depends on it.

Keep these instructions with your vehicle records for future reference.

### **WARNING**

- There are several  **WARNING** and  **CAUTION** sections in this booklet concerning safety when installing or removing the mud flap (front). Always read and follow the instructions in order to prevent injuries, accidents, and possible damage to the vehicle.
  -  **WARNING:** Indicates a situation in which serious injury or death could result if the warning is ignored.
  -  **CAUTION:** Indicates a situation in which bodily injury or damage to the vehicle could result if the caution is ignored.
- For areas indicating the tightening torque in this instruction manual, tighten to the specified torque using a torque wrench. For areas in which the tightening torque is indicated inside parentheses ( ), the tightening torque is indicated as a reference value, however tightening using a torque wrench is not necessary
- Do not modify the mud flap (front).
- Do not install the mud flap (front) in any way other than described in the following instructions.
- If in any doubt, please contact your Mazda dealer to install the accessory in order to prevent errors in installation.
- If you have any questions about the use of the accessory, ask your Mazda dealer for proper advice before using it.
- Mazda and its suppliers are not responsible for injuries, accidents, and damage to persons and property that arise from the failure of the dealer or installer to follow these instructions.
- To ensure safety and reliability of the work, installation, removal and disposal work must be carried out by an Authorized Mazda Dealership.
- Be careful not to lose removed parts, and be sure that they are kept free of dirt, scratches, or damage.

**PART NAME: MUD FLAP (FRONT)**  
**PART NUMBER: DB4F/DB2P/DB4P V3 450**  
**VEHICLE: MAZDA CX-3**

### **NOTE**

#### **To the dealer**

- Please give these instructions to the customer after installation.

#### **To the customer**

- Keep these instructions after installation. The instructions may be necessary for installing other optional parts or removal of this accessory.
- Should the vehicle or this accessory be resold, always give these instructions to the next owner.

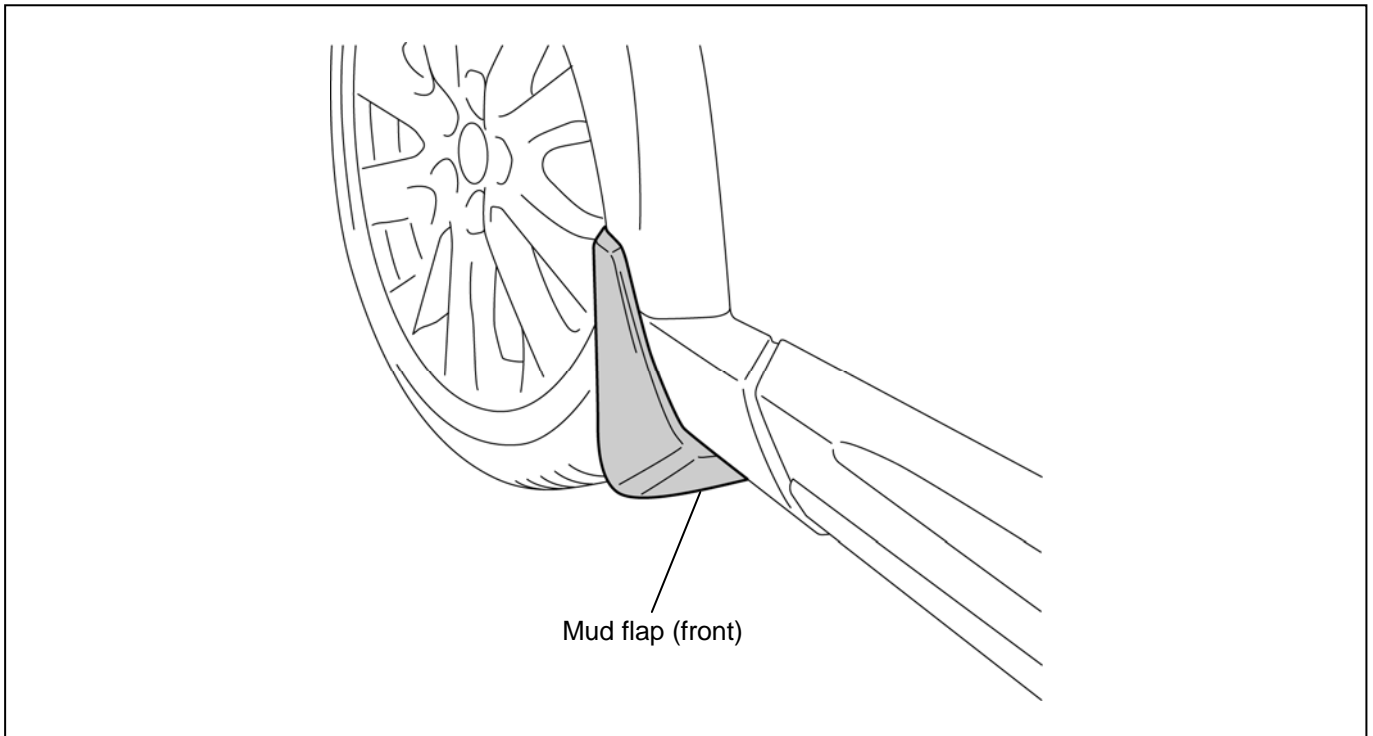

## 1. INSTALLATION VIEW



## 2. PARTS

### NOTE

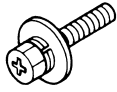
- Before installation, verify that the kit includes all the following parts and that they are free of dirt, scratches, or damage.

Part	Part name	Qty	Part	Part name	Qty	Part	Part name	Qty
	Mud flap (front) RH/LH	1 ea.		Bolt	4		Clip nut	4
	Fastener	2						

# 3. VERIFICATION ITEMS BEFORE INSTALLATION

## ■ REQUIRED TOOLS

- ☆ Phillips screwdriver
- ☆ Fastener remover wrapped with protective tape
- ☆ Needle-nosed pliers
- ☆ Socket wrench (8 mm)
- ☆ Nipper
- ☆ Torque wrench
- ☆ Utility knife

## ⚠ WARNING

Before performing any work, park the vehicle on level ground, apply the parking brake securely, and then block the wheels. If the vehicle moves while performing work, it may cause injury.

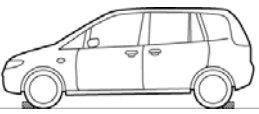

## ⚠ CAUTION

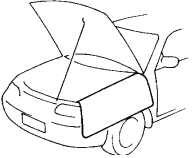
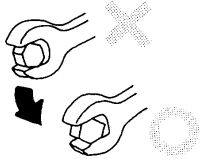
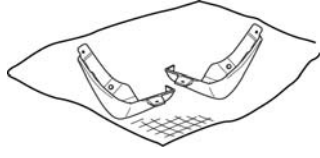
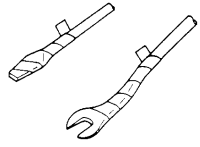
Use masking tape or a protector to prevent scratches when removing/installing parts.	Use the most appropriate (size, use) tool for each task and perform the work correctly. (Otherwise) the parts may be damaged.	Place the removed parts and kit accessories on a protective sheet to prevent scratches.	Wrap protective tape around screwdrivers and fastener remover tools to prevent scratching the vehicle.
			

## ADVICE

Refer to the Workshop Manual for removal and installation of applicable vehicle parts.



## 4. MUD FLAP (FRONT) INSTALLATION

- The figure shows the left side, however, perform the same procedure for the right side.

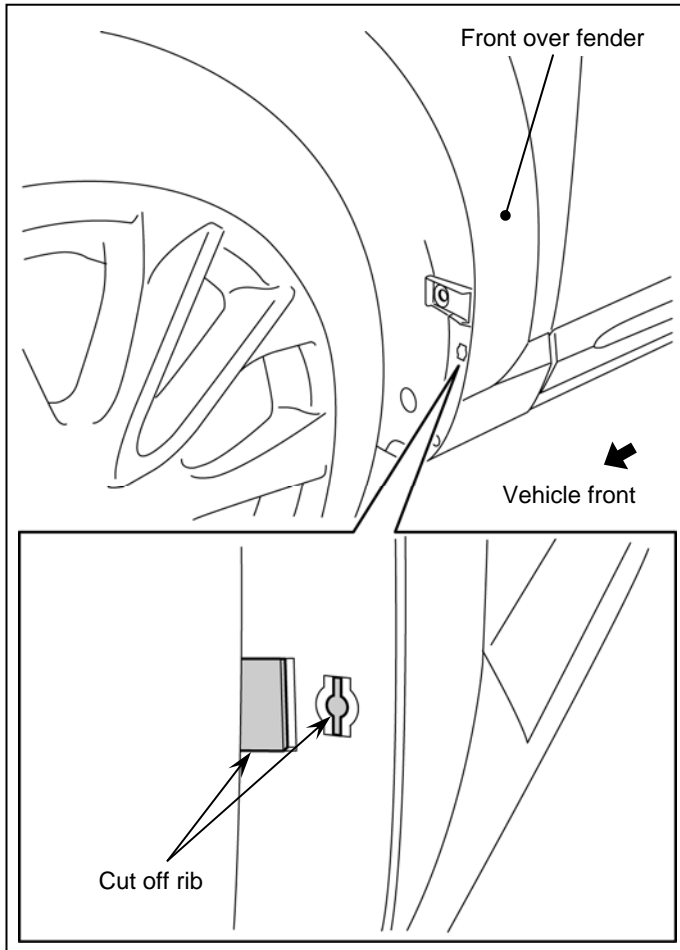

1. Cut off the ribs on the front over fender shown in the figure using nippers.

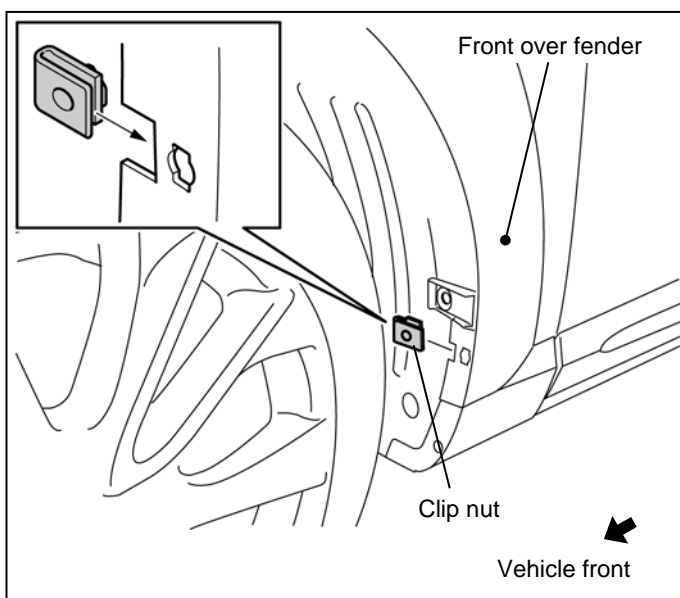

2. Align the front over fender hole, and install the clip nut (1).

### ADVICE

- Install the clip nut with its flat side facing frontwards.

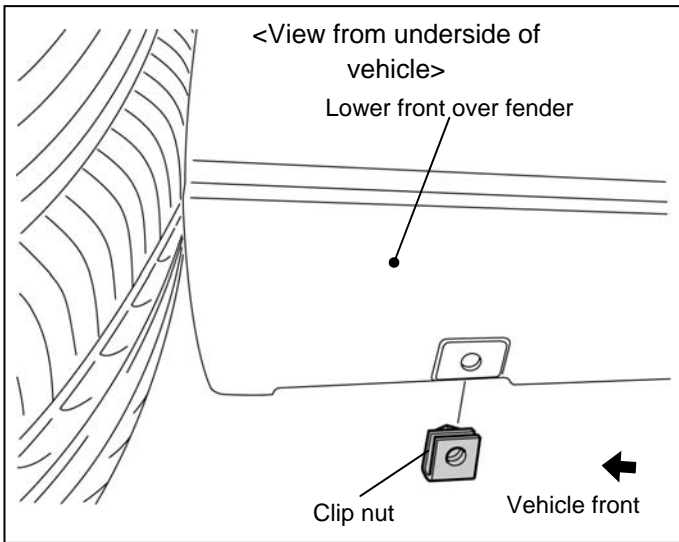

- Align the lower front over fender underside hole, and install the clip nut (1).

**ADVICE**

- Install the clip nut with its flat side facing downwards.

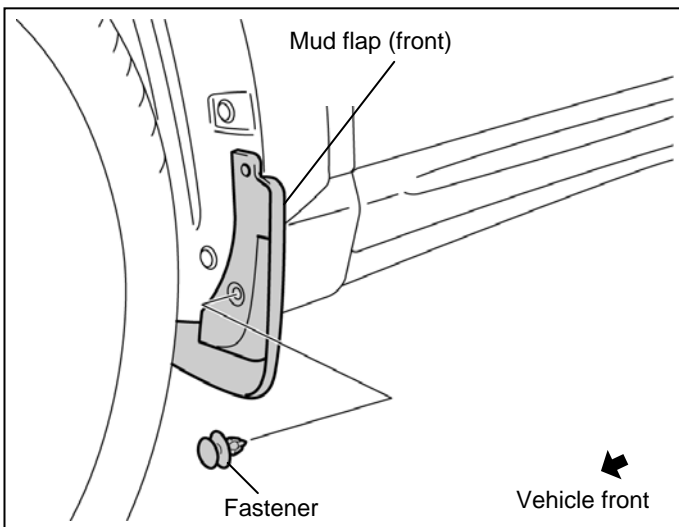

- Align the mud flap (front) with the installation position and install the fastener (1).

**ADVICE**

- Make sure that the fastener is inserted completely.

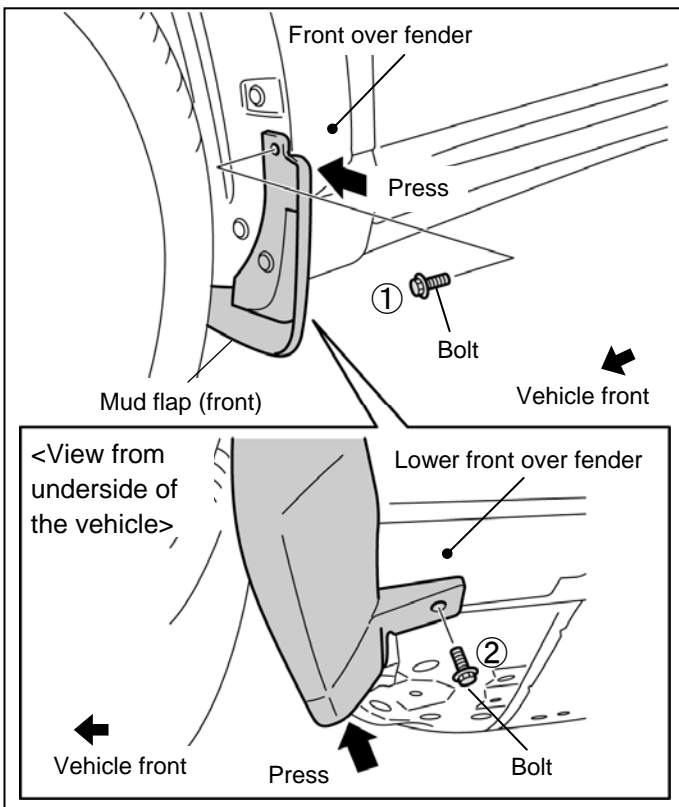

- While pressing the mud flap (front) in the direction of the arrows shown in the figures, attach the bolts (2) in order from (A) to (B).

Bolt tightening torque: (0.8 to 1.2 Nm)

**ADVICE**

- When installing, be careful that there are no gaps between the mud flap (front), the front over fender and lower front over fender.

## 5. VERIFICATION AFTER INSTALLATION

1 . Verify that there are no gaps.

- If there is a gap, loosen the bolt then retighten it while pressing the mud flap (front) against the front over fender and lower front over fender.

2 . Verify that the bolts and fasteners are installed securely.